

QDLASER

QLF063A-AA /QLF063D-AA

660 nm 50mW FP LASER TO-CAN

C00111-01 June 2013



1. DESCRIPTION

The QLF063A-AA/QLF063D-AA are 660 nm quantum well laser devices designed for high output power application. The laser diode is mounted into a TO-56 header including a monitor PD and hermetic sealed with a flat glass cap.

2. FEATURES

- 660 nm FP-LD
- $\Phi 5.6$ mm TO-CAN package
- High output power and high slope efficiency
- Including monitor PD
- Two types of pin assignments: anode common type (QLF063A-AA)/cathode common type (QLF063D-AA)

3. APPLICATIONS

- Industrial laser markers
- Measuring instruments
- Life science applications

4. ABSOLUTE MAXIMUM RATING

(CW operation, $T_c = 25^\circ\text{C}$, unless otherwise specified)

PARAMETER	SYMBOL	RATING	UNIT
Optical output power	P_o	60	mW
LD reverse voltage	V_{RLD}	2	V
PD reverse voltage	V_{RPD}	30	V
Operation temperature	T_c	-10 to 60	$^\circ\text{C}$
Storage temperature	T_{stg}	-40 to 85	$^\circ\text{C}$

5. OPTICAL AND ELECTRICAL CHARACTERISTICS

($T_c = 25^\circ\text{C}$, unless otherwise specified)

PARAMETER	SYMBOL	TEST CONDITION	MIN	TYP	MAX	UNIT
Threshold current	I_{th}	CW	-	55	70	mA
Operation current	I_{op}	CW, $P_o=50\text{ mW}$	-	100	135	mA
Operation voltage	V_{op}	CW, $P_o=50\text{ mW}$	-	2.3	2.8	V
Slope efficiency	η	CW, $P_o=5 - 50\text{ mW}$	0.8	1.1	-	W/A
Monitor current	I_m	CW, $P_o=50\text{ mW}$, $V_{RD}=5\text{ V}$	25	150	300	μA
Peak wavelength	λ_p	CW, $P_o=50\text{ mW}$	655	660	665	nm
Far filed pattern horizontal	θ_h	CW, $P_o=50\text{ mW}$	7	10	13	deg.
Far filed pattern vertical	θ_v	CW, $P_o=50\text{ mW}$	11	14	17	deg.
Beam angle Horizontal	$d\theta_h$	CW, $P_o=50\text{ mW}$	-3	-	3	deg.
Beam angle vertical	$d\theta_v$	CW, $P_o=50\text{ mW}$	-3	-	3	deg.

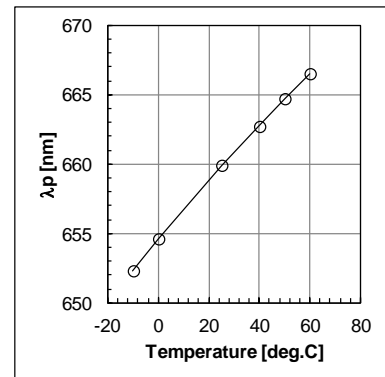
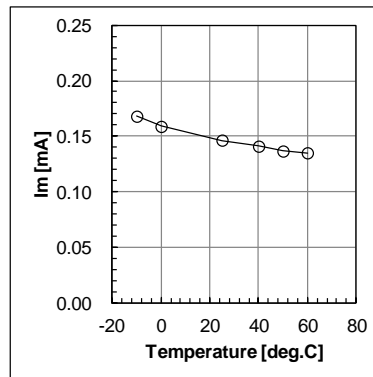
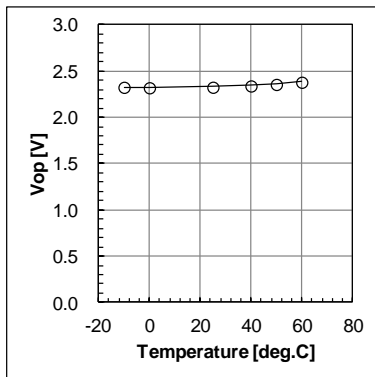
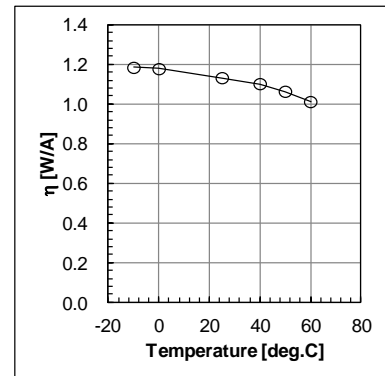
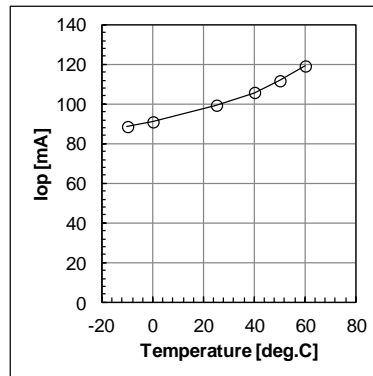
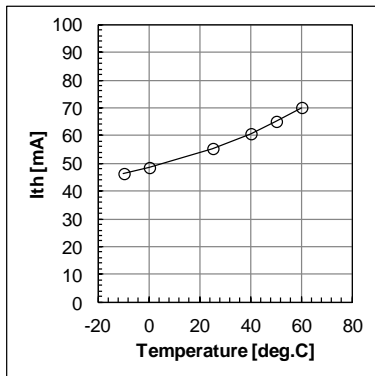

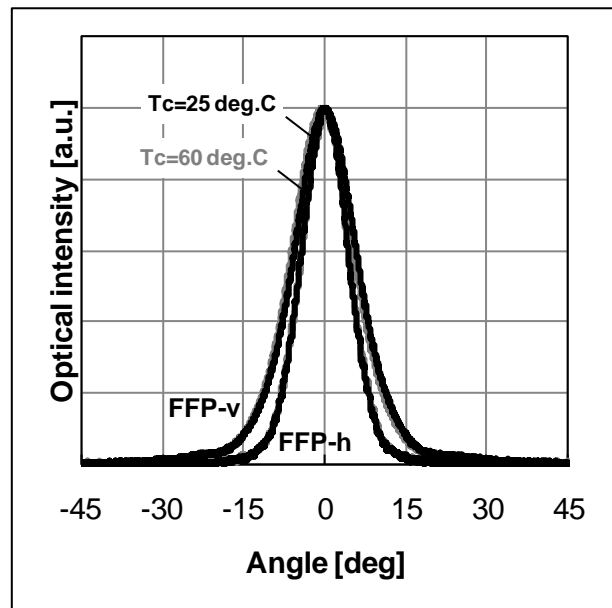
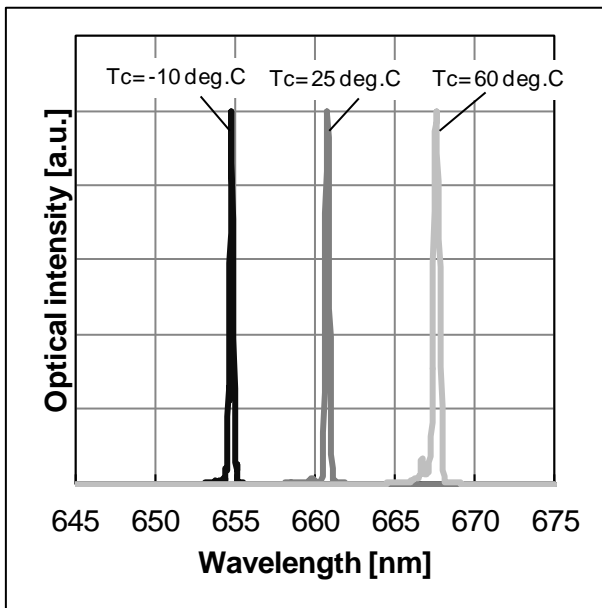
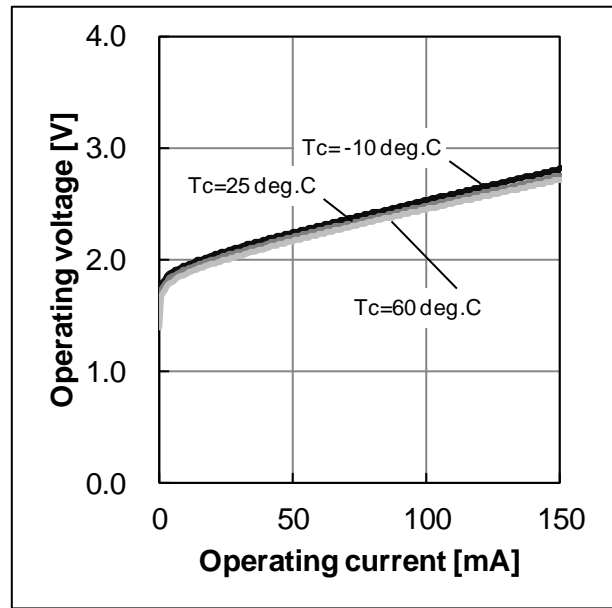
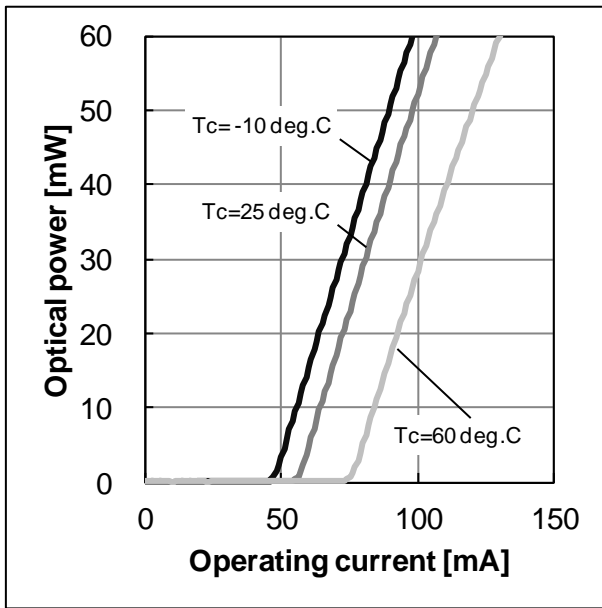

6. OUTLINE DRAWINGS

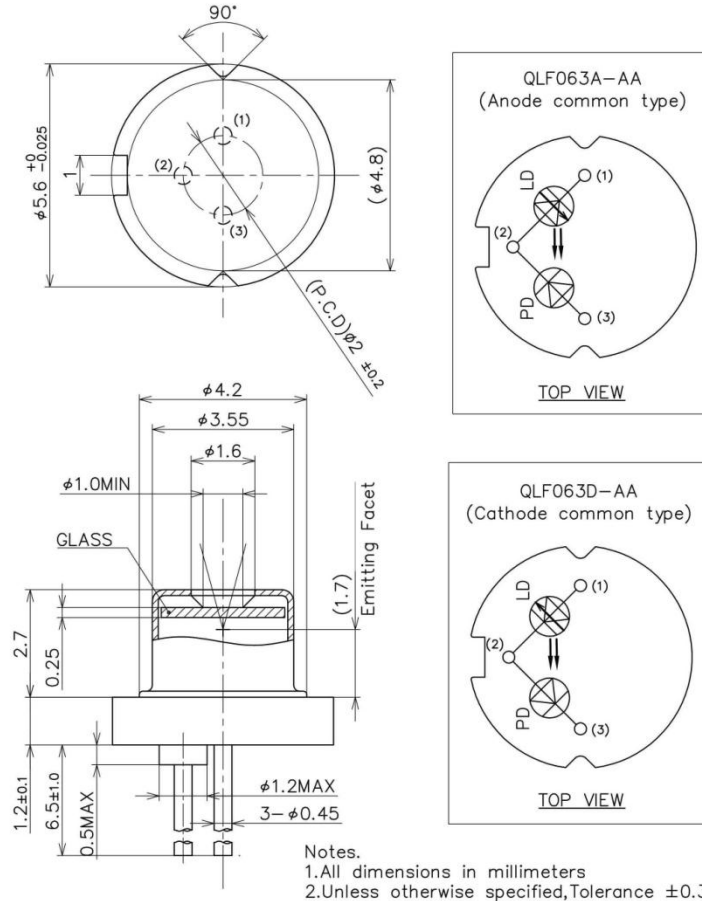

7. NOTICE

- Safety Information

This product is classified as Class 3B laser product, and complies with 21 CFR Part 1040.10.

Please do not take a look laser lighting in operations since laser devices may cause troubles to human eyes.

Please do not eat, burn, break and make chemical process of the products since they contain GaAs material.

- Handling products

Semiconductor lasers are easily damaged by external stress such as excess temperature and ESD.

Please pay attention to handling products, and use within range of maximum ratings.

QD Laser takes no responsibility for any failure or unusual operation resulting from improper handling, or unusual physical or electrical stress.

- RoHS

This product conforms to RoHS compliance related EU Directive 2002/95/EC.

All company or product names mentioned herein are trademarks or registered trademarks of their respective owners. Information provided in this data sheet is accurate at time of publication and is subject to change without advance notice.